

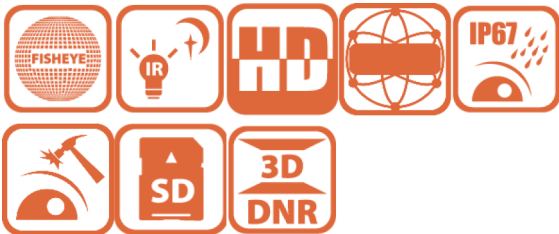

DI-F60MH

6 MP DeepinView IR Network Fisheye Camera

DeepinView^{series}



DI-F60MH is a fisheye network camera capable of providing a 360-degree panoramic image of its scene. The progressive scan CMOS sensor provides high-resolution images of up to 2560 × 2560. Up to 20 live view display modes, designed for 3 mount types, meet various user preferences. Three independently controlled IR lights offer a range of 15 m and provide good vision in low or even zero-light environment.

- Heatmap: based on deep learning algorithms, the camera counts people and presents an intuitive map
- Multi dewarping modes: the image can be dewarped to normal image for viewing intuitively
- Built-in mic and speaker: the camera supports two-way audio for real-time audio security monitoring and communication
- Built-in IR light: an IR range of 15 meters provides good visibility in low or even zero-light environments
- High resolution 6 MP: capturing clear images even when dewarped into 4-image PTZ mode
- Each image is clear and detailed
- Water and dust resistant (IP67) and vandal resistant (IK10)

▪ Specification

Camera	
Image Sensor	1/1.8" Progressive Scan CMOS
Max. Resolution	2560 × 2560
Min. Illumination	Color: 0.01 Lux @ (F2.25, AGC ON), B/W: 0.005 Lux @ (F2.25, AGC ON), B/W: 0 Lux with IR
Shutter Time	1 s to 1/100,000 s
Day & Night	IR cut filter
Lens	
Lens Type	Fixed focal lens, 1.16 mm
Focal Length & FOV	1.16 mm, horizontal FOV 180°, vertical FOV 180°
Iris Type	Fixed
Aperture	F2.25
Depth of Field	0.2 m to ∞
DORI	
DORI	D: 23.2 m O: 9.2 m R: 4.6 m I: 2.3 m
Illuminator	
Supplement Light Type	IR
Supplement Light Range	Up to 15 m
Supplement Light Number	3
IR Wavelength	850 nm
Smart Supplement Light	Yes
HEOP	
Open Resources	Memory: 60 MB, Smart RAM: 800 MB, eMMC: 2 GB
Computing Power	2 TOPS
Open Capability	HEOP 2.0 OpendevSDK
Deep Learning Structure	Caffe, TensorFlow, PyTorch
Programming Language	C, C++

Video	
Main Stream	50 Hz: 25 fps/60 Hz: 30 fps: Fisheye View: 2560 × 2560, 2048 × 2048, 1280 × 1280 180 Panorama View: 2048 × 1536, 1920 × 1440 180 Dual Channel Panorama View: 2048 × 768, 1920 × 720 Panorama View: 2048 × 1536, 1920 × 1440 4PTZ View: camera 01/camera 02/camera 03/camera 04: 1024 × 768 Fisheye + 3PTZ View: camera 01: 2048 × 2048, 1024 × 1024 camera 02/camera 03/camera 04: 1024 × 768 4PTZ Fusion View: 2048 × 1536, 1600 × 1200
Sub-Stream	50 Hz: 25 fps/60 Hz: 30 fps: Fisheye View: 720 × 720, 480 × 480 180 Panorama View: 640 × 480, 320 × 240 180 Dual Channel Panorama View: 640 × 480, 320 × 240 Panorama View: 640 × 360, 320 × 240 4PTZ View: camera 01/camera 02/camera 03/camera 04: 640 × 480, 320 × 240 Fisheye + 3PTZ View: camera 01: 720 × 720 camera 02/camera 03/camera 04: 640 × 480, 320 × 240
Video Compression	Main stream: H.265+/H.265/H.264+/ H.264, Sub-stream: H.265/H.264/MJPEG
Video Bit Rate	32 Kbps to 16 Mbps
H.264 Type	Baseline Profile, Main Profile, High Profile
H.265 Type	Main Profile
Bit Rate Control	CBR, VBR
Scalable Video Coding (SVC)	H.264 and H.265 encoding
Region of Interest (ROI)	4 fixed regions for each stream
Fisheye Display	
Mount Type	Support wall/table/ceiling mounting
Decoding Mode	Support hardware decoding and software decoding

Display Mode	20 display modes in total, Software decoding: fisheye view, 180 panorama view, 360 panorama view, 360 panorama + PTZ, 360 panorama + 3PTZ, 360 panorama + 6PTZ, 360 panorama + 8PTZ, 2PTZ, 4PTZ, fisheye + 3PTZ, fisheye + 8PTZ, hemisphere, AR hemisphere, cylinder, Hardware decoding: fisheye view, 180 panorama view, 180 dual channel panorama, panorama view, 4PTZ, fisheye + 3PTZ, 4PTZ fusion
Audio	
Audio Compression	G.711/G.722.1/G.726/MP2L2/PCM/MP3/AAC-LC
Audio Bit Rate	64 Kbps (G.711ulaw/G.711alaw)/16 Kbps (G.722.1)/16 Kbps (G.726)/32 to 192 Kbps (MP2L2)/8 to 320 Kbps (MP3)/16 to 64 Kbps (AAC-LC)
Audio Sampling Rate	8 kHz/16 kHz/32 kHz/48 kHz
Environment Noise Filtering	Yes
Network	
Protocols	TCP/IP, ICMP, HTTP, HTTPS, FTP, SFTP, DHCP, DNS, DDNS, RTP, RTSP, RTCP, PPPoE, NTP, UPnP, SMTP, SNMP, IGMP, 802.1X, QoS, IPv4, IPv6, UDP, Bonjour, SSL/TLS, ISUP, ARP, WebSocket, WebSockets, SIP
Simultaneous Live View	Up to 20 channels
API	Open Network Video Interface (Profile S, Profile G, Profile T), ISAPI, SDK, ISUP, Support for Session Initiation Protocol (SIP) for integration with Voice over IP (VoIP) systems, peer to peer or integrated with SIP/PBX
User/Host	Up to 32 users 3 user levels: administrator, operator, and user
Security	Password protection, complicated password, HTTPS encryption, 802.1X authentication (EAP-TLS, EAP-LEAP, EAP-MD5), watermark, IP address filter, basic and digest authentication for HTTP/HTTPS, WSSE and digest authentication for Open Network Video Interface, RTP/RTSP over HTTPS, control timeout settings, security audit log, TLS 1.2, host authentication (MAC address)
Network Storage	NAS (NFS, SMB/CIFS), Auto Network Replenishment (ANR), Together with high-end Hikvision memory card, memory card encryption and health detection are supported.
Client	iVMS-4200, iVMS-4500, iVMS-5200, Hik-Connect
Web Browser	Plug-in required live view: IE 10, IE 11, Plug-in free live view: Chrome 57.0+, Firefox 52.0+, Edge 89+, Safari 11+, Local service: Chrome 57.0+, Firefox 52.0+, Edge 89+
Image	
Image Parameters Switch	Yes
Image Settings	saturation, brightness, contrast, sharpness, white balance, AGC, adjustable by client software or web browser
Day/Night Switch	Day, Night, Auto, Schedule, Alarm Trigger
Wide Dynamic Range (WDR)	Digital WDR
Image Enhancement	BLC, HLC, 3D DNR, Distortion Correction, Defog
Privacy Mask	8 programmable polygon privacy masks
Picture Overlay	LOGO picture can be overlaid on video with 128 × 128 24 bit bmp format.
Interface	
Ethernet Interface	1 RJ45 10 M/100 M/1000 M self-adaptive Ethernet port
On-Board Storage	Built-in memory card slot, support microSD/microSDHC/microSDXC card, up to 256 GB

Built-in Microphone	Yes, 4 built-in microphones
Built-in Speaker	Yes, 1 built-in speaker
Audio	1 input (line in), 3.5 mm connector, max. input amplitude: 3.3 Vpp, input impedance: 4.7 K Ω , interface type: non-equilibrium, 1 output (line out), 3.5 mm connector, max. output amplitude: 3.3 Vpp, output impedance: 100 Ω , interface type: non-equilibrium
Alarm	2 inputs, 2 outputs (max. 24 VDC, 1 A)
RS-485	1 RS-485 (Half duplex, HIKVISION, Pelco-P, Pelco-D, self-adaptive)
Reset Key	1 Reset Key
Event	
Basic Event	Motion detection, video tampering alarm, alarm input and output, exception (network disconnected, IP address conflict, illegal login, HDD full, HDD error)
Smart Event	Line crossing detection, intrusion detection, region entrance detection, region exiting detection, scene change detection, audio exception detection, defocus detection, unattended baggage detection, object removal detection
Linkage	Upload to FTP/NAS/memory card, notify surveillance center, send email, trigger alarm output, trigger recording, trigger capture
Deep Learning Function	
People Counting	Counts people entering, exiting and passing by separately (The data is stored in the flash.) Supports real-time uploading and uploading by statistic cycle Sends email reports on daily, weekly, monthly or annually basis Supports up to 3 detection regions, and independent arming schedule and linkage method
Queue Management	Supports up to 8 detection regions, and independent arming schedule and linkage method Supports 2 detection modes: regional people queuing-up, waiting time detection Generates reports to compare the efficiency of different queuing-ups and display the changing status of one queue Supports raw data export for further analysis Supports real-time data uploading and scheduled data uploading Regional people queuing-up: supports 4 alarm trigger conditions, including greater than threshold, less than threshold, equal to threshold, not equal to threshold Waiting time detection: supports 1 alarm trigger condition, including greater than threshold
Heat Map	A graphic description of visits (by calculating amount of people or amount of dwell time) in a configured area., Two report types are available, space heat map and time heat map line chart.
Intersection Analysis	Detects and analyze flow in an intersection-like scene, and generate reports Support one intersection of up to 10 ways
General	
Power	12 VDC \pm 20%, 1 A, max. 11.5 W, two-core terminal block, PoE: IEEE 802.3af, Class 3, max. 12.5 W
Material	Metal
Dimension	\varnothing 140.3 mm \times 59.4 mm (\varnothing 5.5" \times 2.3")
Package Dimension	260 mm \times 230 mm \times 135 mm (10.2" \times 9.1" \times 5.3")

Weight	Approx. 715 g (1.58 lb.)
With Package Weight	Approx. 1206 g (2.66 lb.)
Storage Conditions	-40 °C to 60 °C (-40 °F to 140 °F). Humidity 95% or less (non-condensing)
Startup and Operating Conditions	-40 °C to 60 °C (-40 °F to 140 °F). Humidity 95% or less (non-condensing)
Language	33 languages: English, Russian, Estonian, Bulgarian, Hungarian, Greek, German, Italian, Czech, Slovak, French, Polish, Dutch, Portuguese, Spanish, Romanian, Danish, Swedish, Norwegian, Finnish, Croatian, Slovenian, Serbian, Turkish, Korean, Traditional Chinese, Thai, Vietnamese, Japanese, Latvian, Lithuanian, Portuguese (Brazil), Ukrainian
General Function	Heartbeat, flash log, password reset via email, password protection, one-key reset, anti-banding
Heater	Yes
Cable Length	0.31 m (1.02 ft.)
Approval	
EMC	CE-EMC: EN 55032:2015+A1:2020, EN 50130-4:2011+A1:2014, EN IEC 61000-3-2:2019+A1:2021, EN 61000-3-3:2013+A1:2019+A2:2021, EN 50121-4: 2016+A1:2019, RCM: AS/NZS CISPR 32: 2015, IC: ICES-003: Issue 7, KC: KN32: 2015, KN35: 2015
Safety	UL: UL 62368-1, CB: IEC 62368-1: 2014+A11, CE-LVD: EN 62368-1: 2014/A11: 2017, BIS: IS 13252 (Part 1): 2010/IEC 60950-1: 2005
Environment	CE-RoHS: 2011/65/EU, WEEE: 2012/19/EU, Reach: Regulation (EC) No 1907/2006
Protection	IP67: IEC 60529-2013, IK10: IEC 62262:2002

▪ Typical Application

DiSS products are classified into three levels according to their anti-corrosion performance. Refer to the following description to choose for your using environment.

This model has NO SPECIFIC PROTECTION.

Level	Description
Top-level protection	DiSS products at this level are equipped for use in areas where professional anti-corrosion protection is a must. Typical application scenarios include coastlines, docks, chemical plants, and more.
Moderate protection	DiSS products at this level are equipped for use in areas with moderate anti-corrosion demands. Typical application scenarios include coastal areas about 2 kilometers (1.24 miles) away from coastlines, as well as areas affected by acid rain.
No specific protection	DiSS products at this level are equipped for use in areas where no specific anti-corrosion protection is needed.

▪ Physical Interface

No.	Interface Description
1	Network Interface
2	Power Interface
3	Alarm Interface, RS-485

4	Audio Output Interface
5	Audio Input Interface

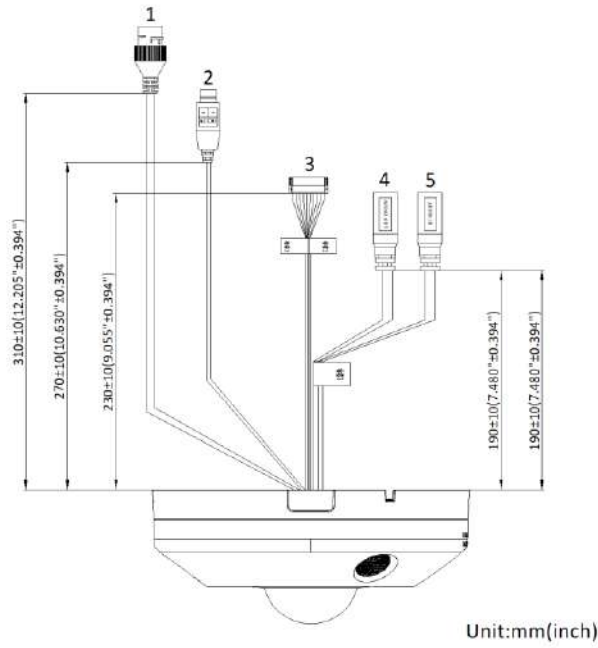

▪ Available Model



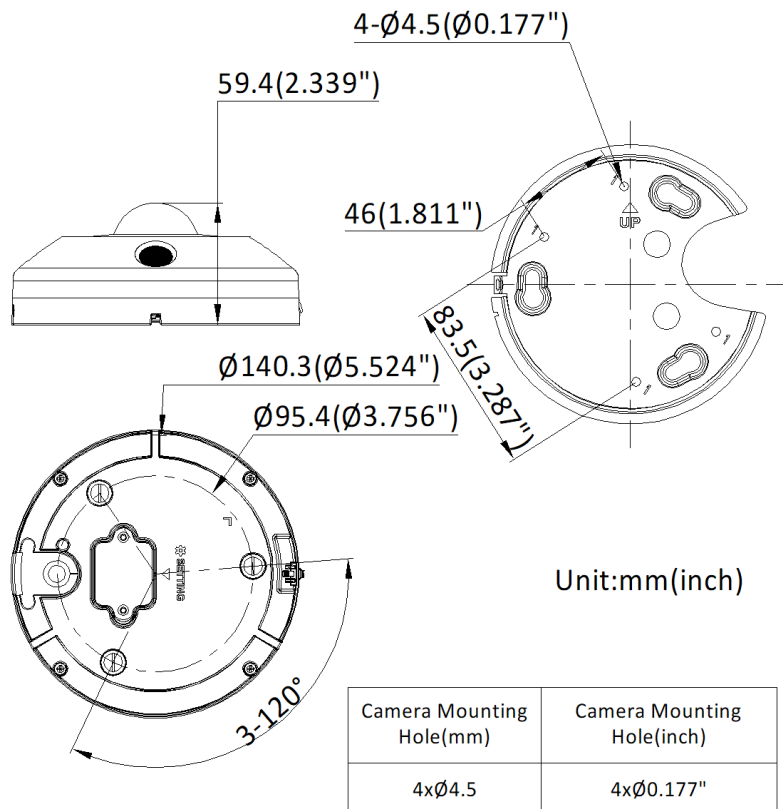

DI-F60MH

▪ Dimension



▪ **Accessory**

▪ **Optional**

DI-1273ZJ-140B Wall Mount	DI-1276ZJ-SUS Corner Mount	DI-1275ZJ-SUS Vertical Pole Mount	DI-2280ZJ-WA140 Junction Box	DI-1273ZJ-140 Wall Mount
				
DI-1271ZJ-140 Pendant Mount				
				

**It is recommended to use DI-1276ZJ-SUS and DI-1275ZJ-SUS with DI-1273ZJ-140 or DI-1273ZJ-140B.*