

Here. There. Anywhere.



Access control. Made even more accessible.



ProtegeWX is a flexible, all-in-one, web based system that integrates access control, intrusion detection, and building automation into one simple unified solution.



JUST OPEN THE BOX: 1... 2... 3...

Transforming the way companies manage their security, ProtegeWX effectively places the office in your pocket and gives you the freedom to configure, control, and monitor your system from anywhere with the swipe of a finger. Web based technology removes the complications and constraints typically associated with software, and the familiarity of a web browser and intuitiveness of the interface make learning a breeze, allowing you to program a site from start to finish with no training necessary.

ProtegeWX is an out-of-the-box, all-in-one system that is quick to setup and intuitive to use. Simply unpack the box, connect the controller and power supply, and launch your web browser. An intuitive wizard-driven interface guides you through the process to configure your system, giving you a fully functional access control and intrusion detection solution within a fraction of the time of conventional software.

Too easy.



NO SOFTWARE = NO COMPLICATIONS

Say farewell to the typical constraints associated with software. A built-in web server means there is no software to install, making deployment quick, simple and straightforward. No more issues with compatibility, lost DVDs, or licensing and connection limits. **So clever.**



ANYWHERE. ANYTIME.

No more dusty old desktop PC hidden away in a maintenance closet and providing a warm place for spiders to nest. The web-based interface gives you the flexibility to work from anywhere - the office, from home, or on the road. All you need is an internet connection and you have anywhere, anytime ease of access to your sites. **That's flexible.**

Control. In the palm of your hand.

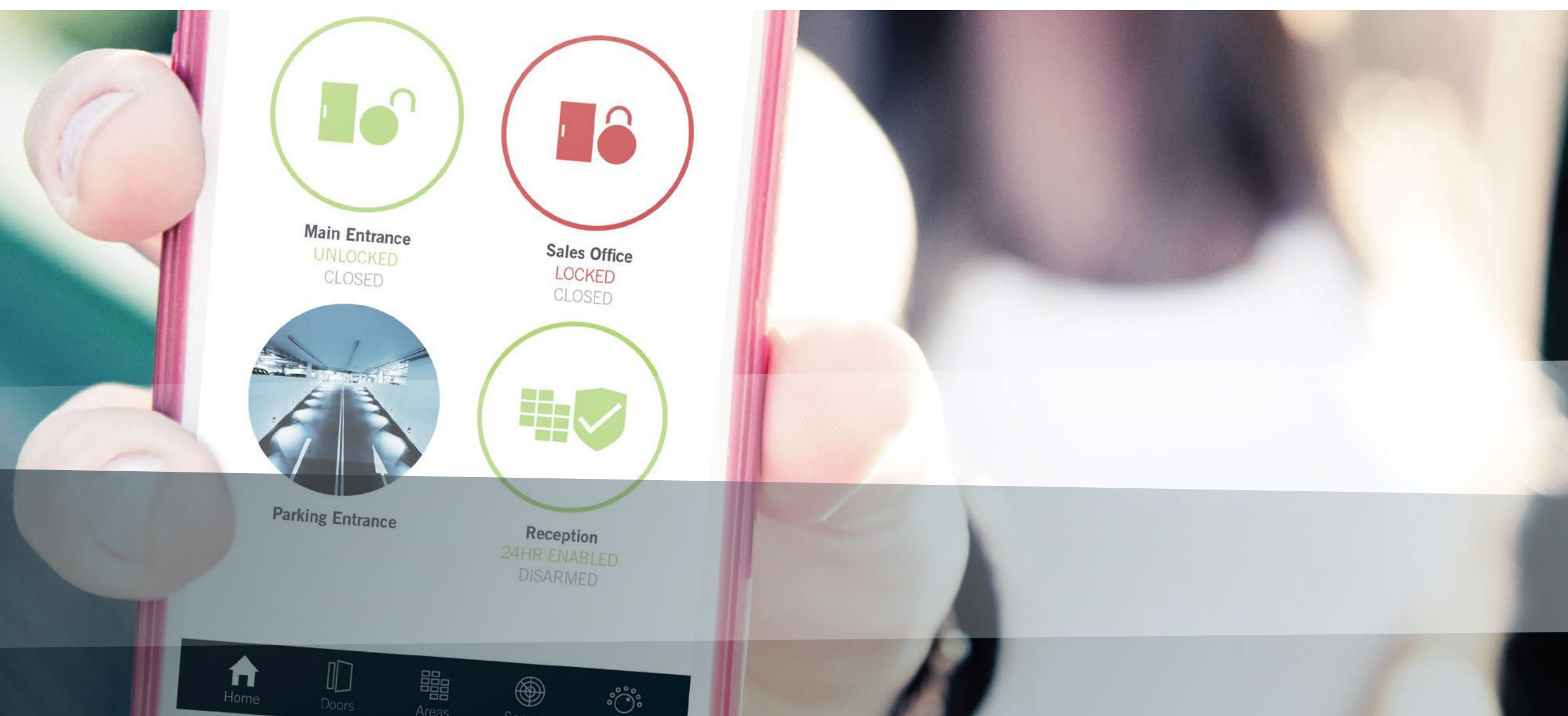

Use the Protege Mobile App to monitor and control your home or business while on the go, all from your smartphone. With the swipe of a finger you can connect to any of your sites, check the status, arm or disarm, control lights, locks, signage, heating – even cameras - from anywhere, at any time.

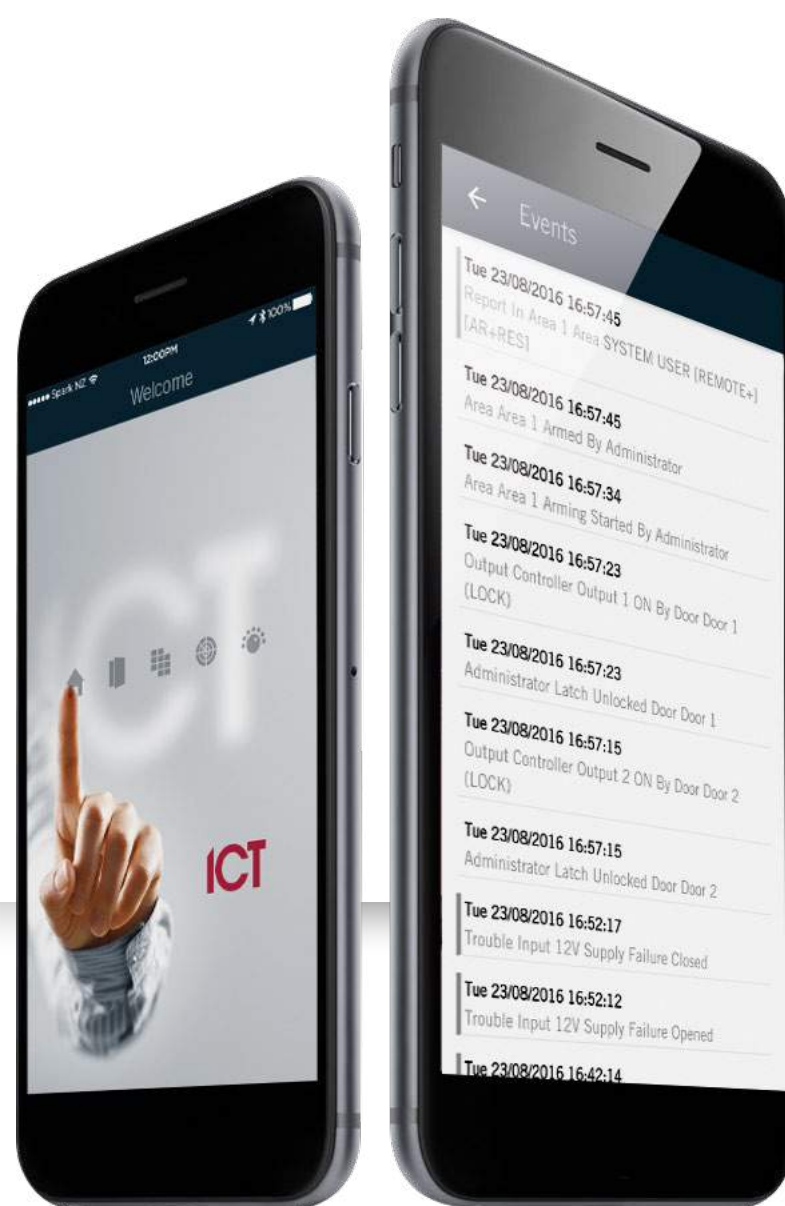

No more second guessing whether you set the alarm before you left the office – the app provides instant awareness of system status, and enables you to arm or disarm with a simple tap. Fumbling for the garage remote becomes a thing of the past as you can use your phone to open the door. And forget about coming home to a cold, dark, unwelcoming apartment. A couple more taps and you have the heating and lights turned on, all from the comfort of your car.

Subscribe to push notifications* to receive alerts of system or sensor activity. As a parent you get peace of mind to see the system disarmed when the kids return home from school. As a business owner, you see that the system is disarmed at the start of the day, and rearmed when everyone goes home. And of course, you're alerted instantly to any alarms.

*Charges may apply.
Refer to the terms and conditions for full details.

Integrated access control and intrusion detection.

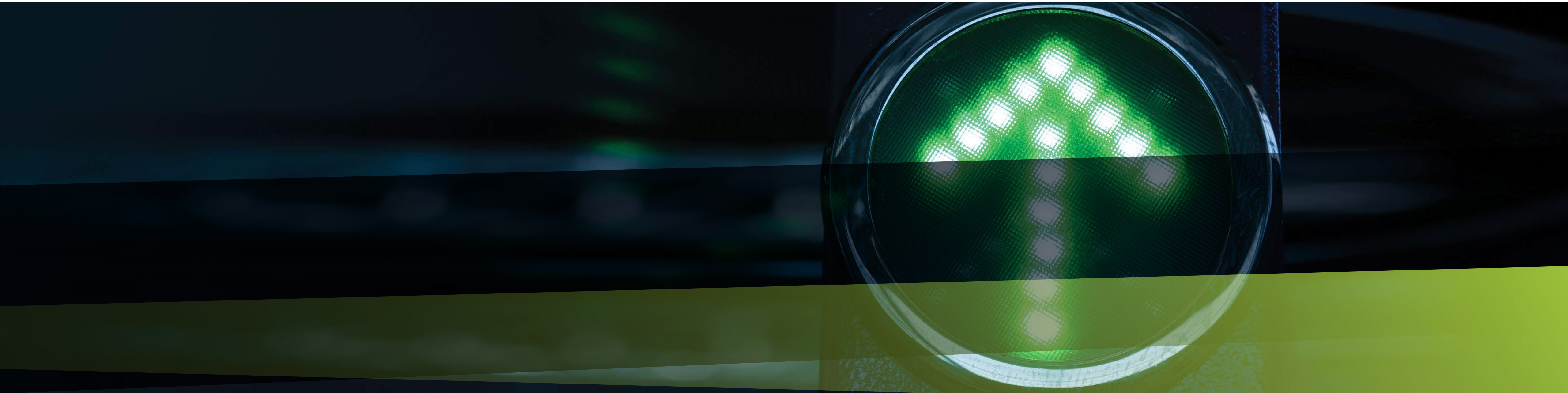

Traditionally, access control systems and intrusion detection systems have worked independently of each other. ProtegeWX brings these together to provide a single cohesive and unified solution that helps you keep unwanted visitors outside, while enabling you to monitor and control access inside. All without having to break a sweat. Not only is an integrated solution a more cost effective option than two disparate systems, the features it unlocks lead to improved staff safety and a higher level of security, while creating a more user friendly solution that is simpler to use and more efficient to operate.



Not only is an integrated solution a more cost effective option than two disparate systems, the features it unlocks lead to improved staff safety and a higher level of security, while creating a more user friendly solution that is simpler to use and more efficient to operate.

ACCESS CONTROL

Badge your card and the light goes green. At face value, access control is pretty simple... Most access control systems appear to do the same things, but the devil is in the detail. ICT delivers electronic access control with a twist. ProtegeWX offers an all-in-one solution that is feature rich yet simple to use.

- Integrated Intrusion Detection: Built in full featured intrusion detection provides user convenience and intelligent control.
- Door Alarm Monitoring: Monitor for forced and open too long doors. Send signals offsite via IP Monitoring or ContactID.
- Advanced Scheduling: Intelligent time based control of access and energy management, automatically adjusts for daylight savings and holidays.
- Elevator Control: Control access to elevator floors, schedule floor unlocking and even integrate with intruder detection.
- Area Counting: Limits the number of people in an Area. Great for carparks and hazardous areas.
- Dual Authentication: Requires two authorized users to supply credentials to gain access to a door.
- Two Factor Authentication: What you have (card) and what you know (PIN) - prevents a lost or stolen credential from being used to gain unauthorized access.
- Multiplex / Multidrop: Doors requiring both Entry and Exit card readers only use a single reader port on Protege hardware for a cost effective solution.
- Anti-Passback: Prevents users from passing their credential back for another user to borrow and stops users entering an area by following or tailgating another user.
- Loiter Areas: Allows users to transit through an area but prevents them from remaining too long or loitering.
- Door Lockdown: Lockdown a single door or the entire site to restrict entry, exit, or all access during an emergency situation.
- Door Interlocking: Allows only a single door in a defined group to be open at one time. Ideal to prevent dangerous things getting in or out of a hazardous area. (Also known as a 'man trap' or 'sally port').
- Multiple User Credentials: Up to 8 different credentials supported per user, allowing the use of multi card technologies, biometrics and other credentials.
- Extended Access Time: Provides additional time for particular users to make their way through selected doors.
- Emergency Egress: Unlock a single door, an egress path, or the entire site, to facilitate a smooth and trouble free emergency evacuation.
- Access Level Outputs: Identify and react to an individual user or groups of users as they pass through a door to automate control of lighting or intrusion areas.



INTRUSION DETECTION

Detecting an intruder and raising the alarm is the easy bit. Making intrusion detection simple, smart and convenient is where we shine... If you are anything like us, you'll value your people as your most precious assets. Intrusion detection is all about protecting your people and securing your other assets. ProtegeWX makes securing your premises a breeze.

- Integrated Access Control: Built in full featured access control provides user convenience and intelligent control.
- Scheduled Area Control: Automatically arm or disarm areas based on time of day. Use Deferred Arming to allow hardworking employees to stay late.
- IP Monitoring: Integrated IP monitoring on-board all Protege system controllers. Fast, accurate, cost effective and always online.
- Automation and Control: Integrate with 3rd party automation and lighting control systems to create a responsive environment.
- Area Counting: Provide user convenience by automatically arming the area when the last person leaves.
- Child Areas: Automatically arm or disarm related areas. Can be used to arm a common area in multi-tenant situations.
- Configurable Input Types: Multiple input types support a range of detection devices for motion, panic, smoke, etc. Create custom types for maximum flexibility.
- Multiple Area Support: Multiple areas allow a building or site to be partitioned. Area Groups give users the ability to control their own areas and arm all with one keypress.
- Disarm Delay: Use Disarm Delay to deter armed robberies. Once a user requests an area disarm a delay timer is started. Once expired, the area disarms.
- Dual Code Control: Requires two authorized users to enter their PIN codes to disarm a restricted area.
- Automatic Re-arm: Automatically arm an area once it has been disarmed for a period. Limit the duration that a user can remain in an area.
- Duress Alarm: Allows users to arm or disarm an area as normal, but sends a silent alarm to the offsite monitoring station.
- Stay Arming Mode: Allows the perimeter of the building to be armed while the occupants are safe and free to move around inside.
- Customizable Keypad: Customize the display and function of keypads. Can be tailored per user and per keypad to provide an intuitive user experience.
- Keypad Privacy: Optional keypad privacy mode dims backlighting to prevent lighting up bedrooms at night and hides the area status display from prying eyes.
- Configurable EOL: Saves on installation time when upgrading from an existing system. Simply select the EOL value that the old system used.

Smarter schedules.



Keeping track of time is a fairly fundamental requirement of any access control system, but making this simple to manage and flexible allows schedules to be used for so much more. ProtegeWX's advanced schedules allow complex rules to be created, based on time of day, holidays, and just about any other condition to make schedules smart and responsive.



Latch unlocking a door during business hours is a common requirement in the retail industry and on public entries in most buildings, and is a feature provided in most access control systems. But dealing with an unplanned closure or when the unexpected results in nobody turning up for work? That is another thing altogether.

A range of configurable options allow schedules to make smart decisions about when to unlock something or turn something on, including a 'late to open' function that prevents a door from unlocking on schedule until the first person arrives for the day, and that keep your building secure while the alarm is armed.



RELIABLE.

Features such as NTP time synchronization, automatic adjustment for daylight savings, holiday programming and schedule qualification mean you can rely on your Protege controller to ensure things happen on time and that you won't arrive to find your front door unlocked unexpectedly.



RESPONSIVE

All the smart programming in the world can't be prepared for the unexpected. Sometimes the time is right but some other condition is not. Protege schedules can be qualified by just about any other condition (or conditions) to ensure your schedule always does what it should. Why unlock a door if nobody turns up for work?



INTELLIGENT

Turning devices off based on time of day can lead to big savings on your energy bill. Eliminate the biannual maintenance required with manual time switches by using a smart schedule that automatically adjusts for daylight savings, and holidays.

Offsite monitoring. That's always online.



Offsite monitoring provides added peace of mind by ensuring security personnel are alerted when an alarm is activated so that a response can be initiated, security guards dispatched, or emergency services summoned. All ProtegeWX controllers include an onboard Ethernet adapter with built in IP reporting functionality, with standard two-door controllers also including an onboard modem to communicate alarms via a traditional telephone line.



Moving to a fully IP solution utilizes your existing internet connection and can provide significant savings by removing the maintenance costs, line rental and user charges associated with copper phone lines. It also uses such a small amount of bandwidth that it can sit on your existing network without any noticeable effect on other network traffic, and certainly won't 'tie up' the internet connection the way an alarm dialer does with a phone line.

A key feature of IP monitoring is that is essentially always online. Many alarm diallers only test once every 24 hours, or sometimes once every 5 days! Message transmission is almost instant, and a lost connection can be detected almost immediately.

Once you've programmed your site, simply click the Central Station Report to generate a report map that can be sent to your monitoring station.

FAST, ACCURATE, COST EFFECTIVE AND ALWAYS ONLINE.

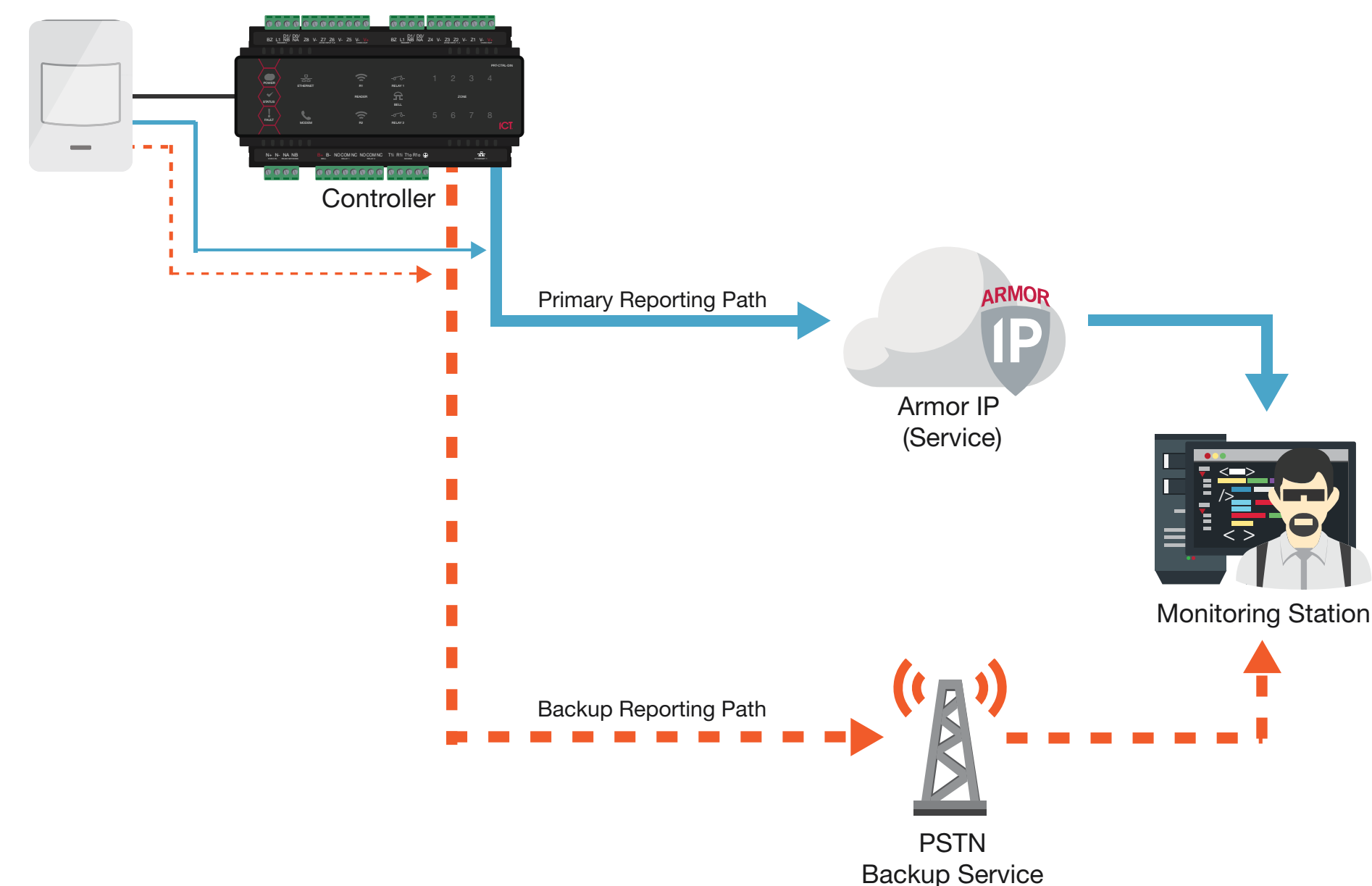

Real time monitoring and reporting. Anywhere. Anytime.

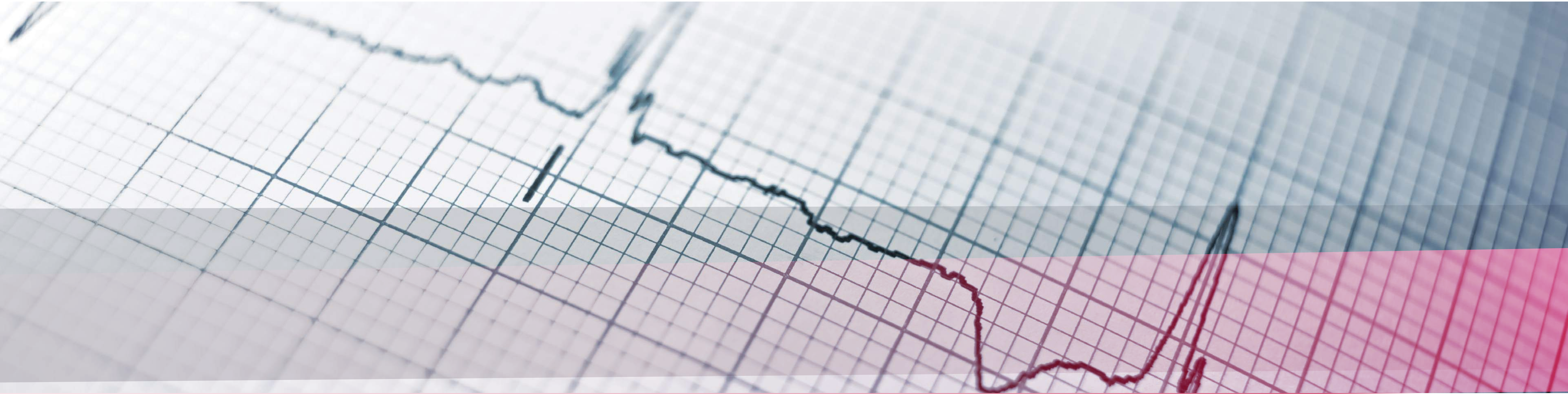

In a busy site events can fly by quickly. While an installer or technician needs to have all the intricate details of the system available to them, an end user monitoring the site wants to be able to assess the system at a glance and control items easily.

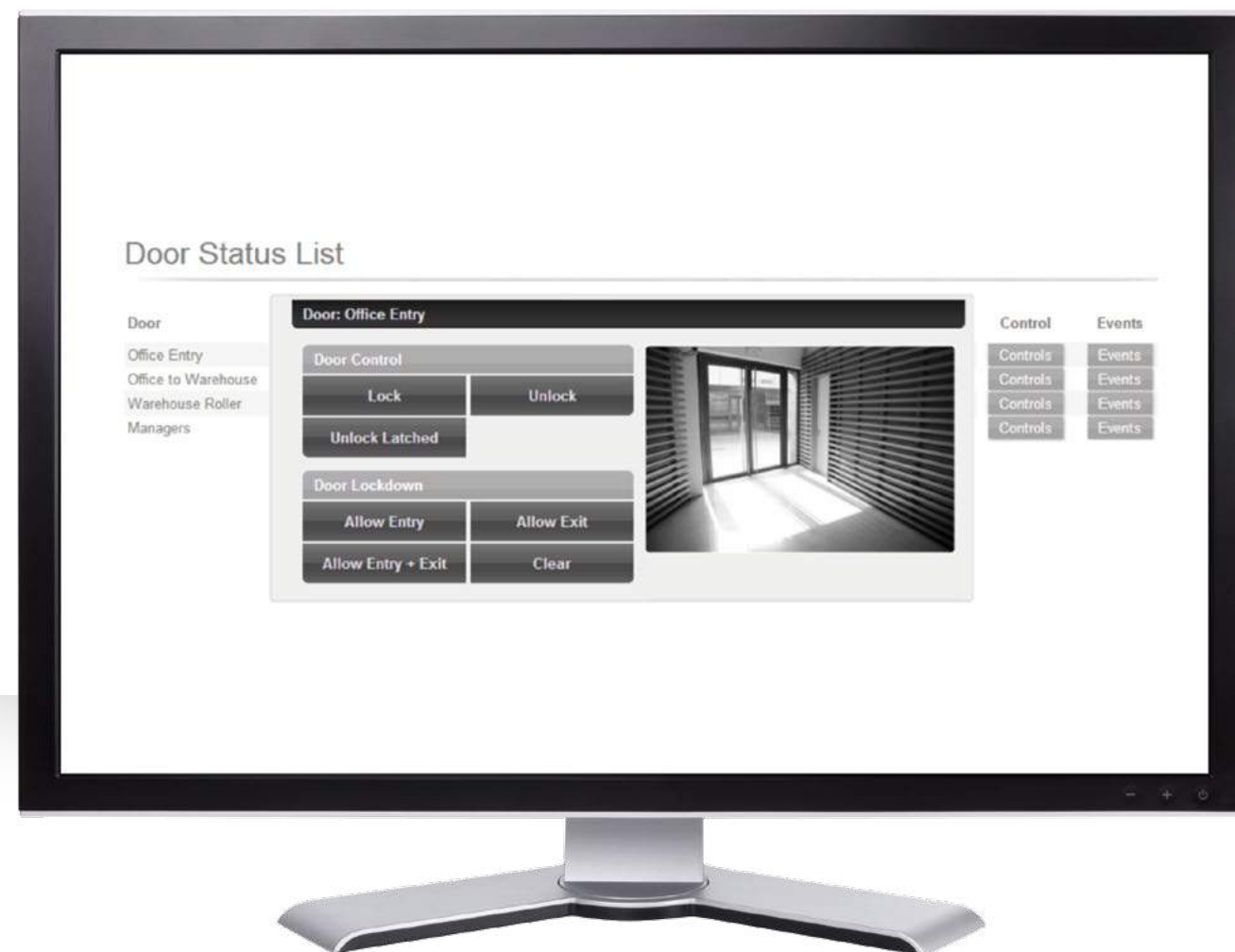

The All Events page provides a full live and historic view of all events within the system, while the Event Reports enable you to quickly and easily identify the relevant information you need and allow you to filter events based on specific users, doors and/or areas, such as:

- what a particular user or group of users has accessed on site
- which users have been through a specific door
- whether an individual user has been through a particular door
- which user has armed an area
- whether an individual user has disarmed a particular area

Event data can also be exported in CSV format which can then be formatted and manipulated as required to create custom reports. Filtering isn't confined to reports. Simply click the Events tab from any user, area, or door, to quickly access a full list of all recent events associated with that record.

Status lists provide a real time display of the devices configured within the system while enabling you to manually control those items from anywhere using your web browser. Lock and unlock doors, or arm and disarm areas no matter where you are – at the office, at home, or out on the road.

Link IP cameras to the system to view the live feed directly from the door monitoring page – and see just who's behind the door before you open it. You can even view multiple camera feeds simultaneously.

Optional licensed features and advanced mode.



ProtegeWX launches in basic mode with full access control and intrusion detection ready to go. The more complicated features are hidden, making the system more intuitive and simple to use. The optional advanced mode enables you to unlock extended functionality including building automation, programmable functions, elevator control, and additional advanced features.



WIRELESS LOCKING INTEGRATION

Expand your existing access control system without the limitations, cost, and inconvenience normally associated with hard wired doors by integrating ProtegeWX with a wireless and offline locking solution from SALTO SALLIS, Aperio, or Allegion.

Wireless solutions not only enable keyless access where previously only a traditional lock and key approach was possible, the wire free environment means there is no need to hard wire the building, allowing you to keep your original doors and locks in place making installation quick, simple, and cost effective. The ability to use your existing credentials means you also avoid any expensive migration costs.

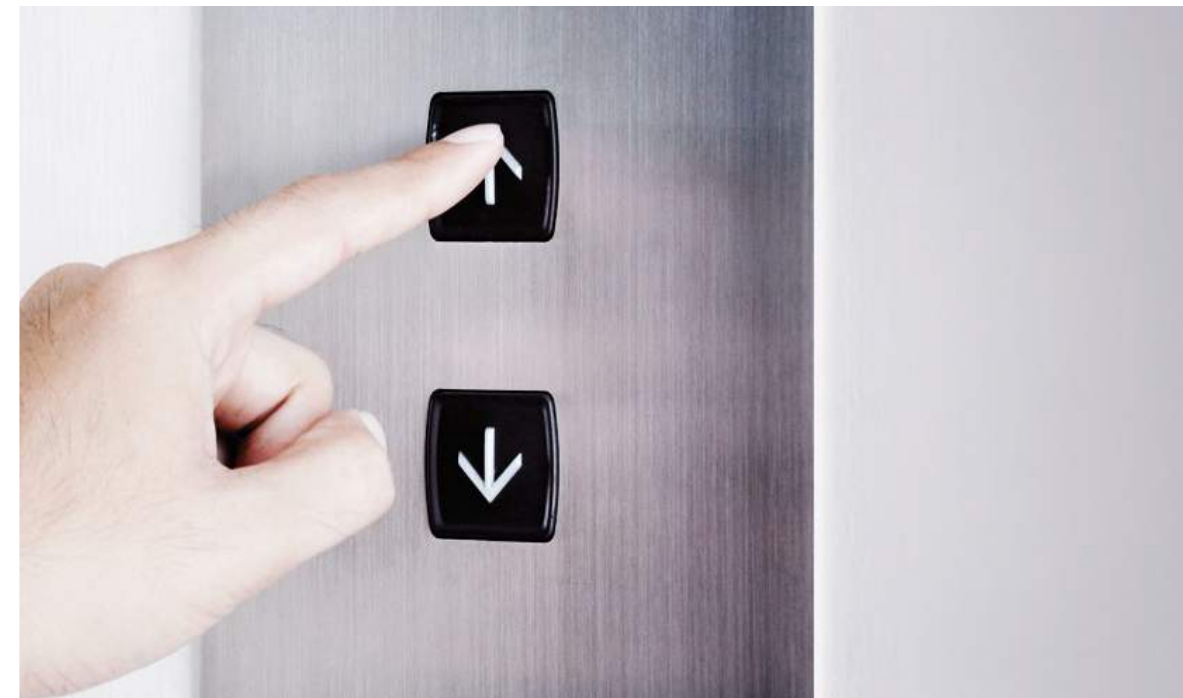

ELEVATOR CONTROL

ProtegeWX is not limited to controlling access to doors. Buildings that have elevators often require access to floors to be controlled as well. Low level elevator integration enables cost effective access control of almost any elevator system, regardless of age or capability.

As well as controlling access to floors, elevator control allows the

- Scheduled unlocking of a floor

- Prevention of scheduled unlocking until the first person arrives (Late to Open)

- Unlocking the elevator when the floor area is disarmed

- Prevention of access if the floor area is armed



CAMERA INTEGRATION

Monitor any IP camera that allows direct URL access to either a static JPG image feed or a streaming MJPG video feed, and view the live feed directly from the door monitoring page. You can even view multiple camera feeds simultaneously.

Provided you can view the raw camera image by pasting the URL into your browser, the camera can be viewed within ProtegeWX.

Building automation.



Public perception and tighter budgets have seen energy efficiency become increasingly important in today's environment. Automated building solutions that reduce energy consumption are one of the simplest ways of reducing costs. Protege provides a simple, single-point solution that balances energy efficiency with the needs of your organization. Now that's smart.



Your ProtegeWX systems holds a wealth of data about a building and the occupants – who is onsite, where they are, and even where they are likely to be going. Knowing when an area is occupied and how many people are in a room, allows for tight control of air conditioning, lighting, and other building systems. Extend efficiency by using this data to make some intelligent decisions around how the building is run.

→ Configure lighting to come on progressively as staff arrive and turn off as they leave

→ Turn heating off over weekends and holidays for a significant reduction in energy use and greater cost savings

→ Activate lighting in low occupancy areas (such as restrooms and storage areas) only when sensors detect motion

→ Adjust lighting levels based on current ambient light

→ Control lighting based on areas that employees onsite are allowed to access

→ Set lighting to adjust to full power when cleaners arrive in the evening to ensure good visibility

→ Turn off non-essential items automatically when the alarm is set at the end of the day, and on again when the alarm is deactivated

→ Configure HVAC systems to maintain a lower temperature when a building is unoccupied and increase to a comfortable temperature as people arrive for the day

→ Turn off air conditioning when a window is opened, then back on when the window is closed



The Automation and Control or C-Bus services can be used to provide a generic interface for integration with third party automation products such as that provided by Savant, Control 4, Crestron, AMX, C-Gate, and Command Fusion, or those using the Clipsal C-Bus protocol.

ICT's Automation and Control protocol turns ProtegeWX into an open book, enabling developers to create their own custom integrations. Designed to allow third party automation products to communicate directly with Protege controllers, the protocol enables you to control doors, areas, outputs, inputs and variables, anywhere in the system, and to monitor the status of these items then report back if the status of the item changes.

Programming language independent, it defines how a third party system will communicate with a Protege system, and allows you to control your security system, building access, air-conditioning and lighting from a single interface device without the need for overly complicated software. When ease of use is paramount, a simple press, tap, or swipe can arm and disarm areas, check the state of the system, and lock or unlock doors.

Start small today. Go big tomorrow.



SYSTEM CAPACITIES	WX	GX
Users	10,000	Unlimited
Events	50,000	Unlimited
Schedules	512	Unlimited
Doors	128	Unlimited
Areas	32	Unlimited
Inputs	512	Unlimited
Outputs	512	Unlimited
Keypads	200	Unlimited
Input Expanders	248	Unlimited
Output Expanders	32	Unlimited

The modular hardware design provides the flexibility to accommodate any installation whether it's small, large, residential or commercial. Expandable modules allow you to scale your system as your requirements change. Start with the controller or choose one of the cost-effective starter kits, then add optional accessories as and when you need them. Need more PIRs? Add a Protege Input Expander. Want more doors? Add a Protege Reader Expander.



- TCP/IP Ethernet Connection
- Encrypted RS-485 Module Network
- Wireless Connection
- RS-485/Wiegand Card Reader Connection
- Security Cable Connection
- RS-485 Wireless Lock Hub/Gateway Connection
- Wiegand Connection

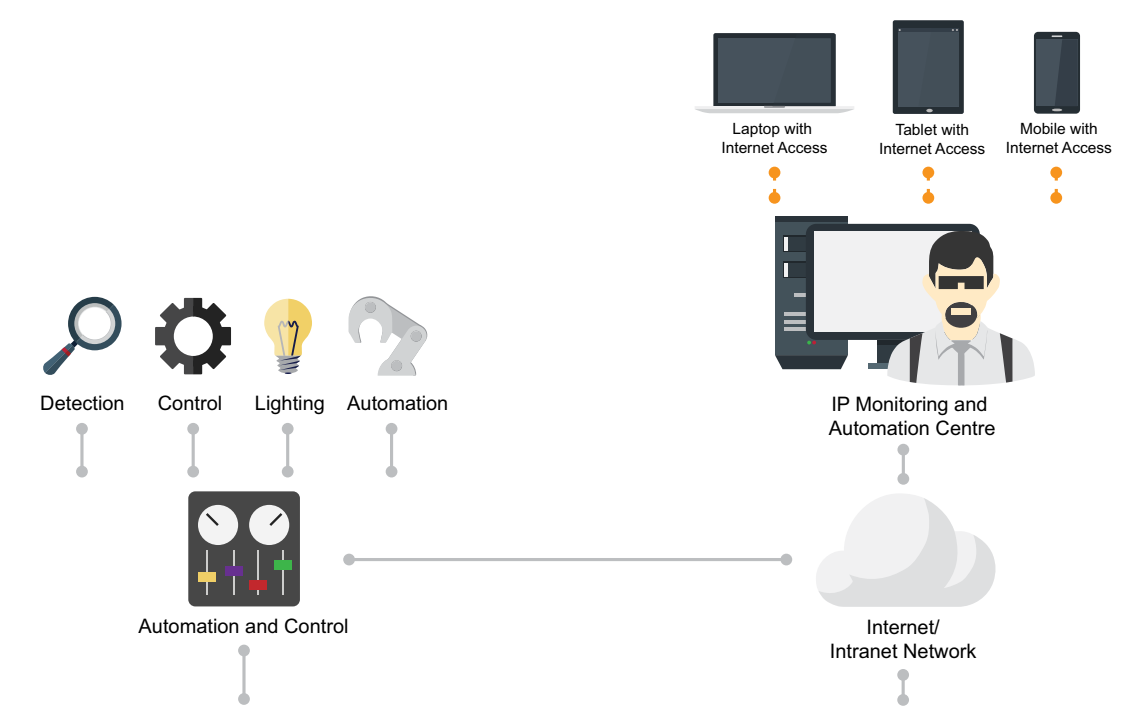
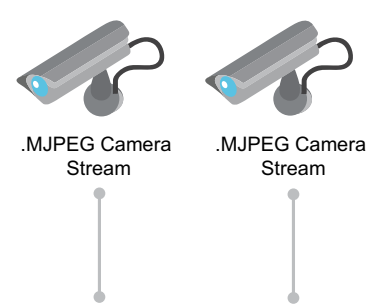

WAN/LAN Ethernet Connection

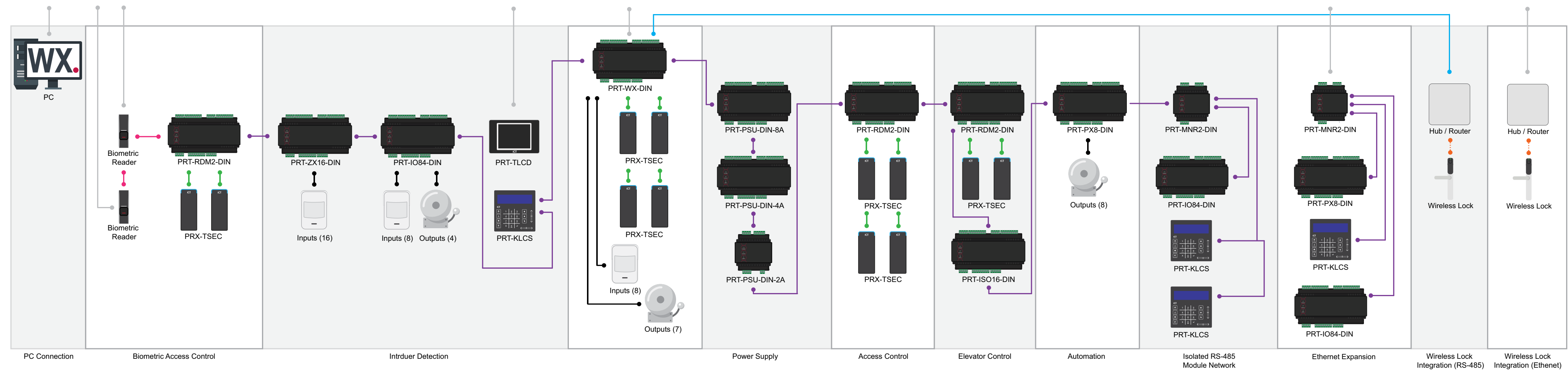

ProtegeWX DIN Rail Controller



The heart of the ProtegeWX system, the Controller is the central processing device responsible for managing security, access control and building automation, while providing seamless control from a browser interface.

All Controller models provide onboard access control, with the key difference being the reader ports and number of doors that can be controlled without the need for additional hardware. The standard controller features two reader ports allowing the connection of up to four readers (two entry, two exit) controlling two doors. Reader ports can be configured for either Wiegand or RS-485 reader operation. The single door controller has one RS-485-only reader port allowing the connection of two RS-485 readers providing entry and exit control of one door. Further doors can be controlled by adding reader expanders (up to a maximum of 128 doors)

PROTEGEWX DIN RAIL SYSTEM CONTROLLER

→ 2 doors (4 readers),
RS-485 or Wiegand

→ 8 multi purpose inputs

→ 1 monitored bell output

→ 2 Form C relay outputs

→ 4 low current outputs

PROTEGEWX DIN RAIL SINGLE DOOR CONTROLLER

→ 1 door (2 readers), RS-485
only, Wiegand not supported

→ 2 multi purpose inputs

→ 1 Form C relay output

→ Optional PoE

- Fully integrated access control and intrusion detection for user convenience and increased efficiency

- Secure encryption algorithms and the latest HTML5 web standards ensure your data is locked safely away onboard the Controller

- Built in IP reporting capability and an onboard modem provides a fast, accurate, and cost effective offsite monitoring solution

- Integrate with third party products such as SALLIS, Aperio, Allegion and Savant, or have your own developers use the ICT Automation and Control protocol to create a custom integration.



- Updates are a breeze to apply. Simply upload the update file then follow the onscreen instructions. Even our expansion modules can be updated using this same simple process.

- Automation points for managing controllable devices such as lighting, air conditioning and signage

- Optional PoE (Power over Ethernet) for both data connection and power supply

- Comprehensive front panel LED indicators display device status at a glance

Technical specifications.

To connect to the ProtegeWX web interface from outside your local area network, you need to configure port forwarding on the router/modem being used. For instructions on routing the ports required, please refer to the **ProtegeWX Connectivity Guide**.

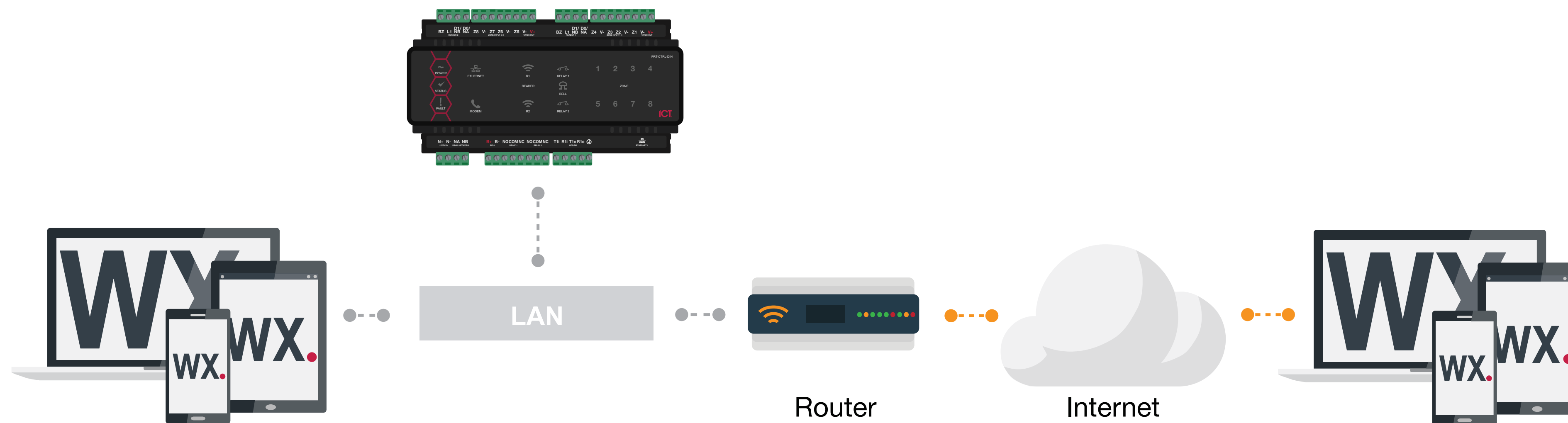

*The Total Combined Current refers to the current that will be drawn from the external power supply to supply the Controller and any devices connected to the Controller's outputs. The Auxiliary outputs and Bell output are directly connected via electronic fuses to the N+ N- input terminals, and the maximum current is governed by the trip level of these fuses. **Each reader port supports both Wiegand and RS-485 operation but not at the same time. If combining Wiegand and RS-485 technologies, they must be connected on separate ports.

ICT continually strives to increase the performance of its products, and as a result these specifications may change without notice. We recommend checking the ICT website for the latest documentation and product information.

	PRT-WX-DIN	PRT-WX-DIN-1D	PRT-WX-DIN-1D-POE
Operating Voltage	11-14V DC		
Operating Current	120mA (typical)		
DC Output	10.45-13.85VDC 0.7A (typical) electronic shutdown at 1.1A	10.45-13.85VDC 0.7A (typical) electronic shutdown at 1.1A	13VDC +/- 0.5 0.7A (typical) electronic shutdown at 1.1A
Bell DC Output (Continuous)	14.4-13.45VDC 8 Ohm 30W siren or 1.1A (typical) electronic shutdown at 1.6A	-	-
Bell DC Output (Inrush)	1500mA	-	-
Total Combined Current*	3.4A (Max)	0.82A (Max)	0.82A (Max)
Battery Charging	-	-	300mA (typical)
Battery Low	-	-	11.2VDC
Battery Restore	-	-	12.5VDC
Electronic Disconnection	9.0VDC		
Communication (Ethernet)	10/100Mbps Ethernet communication link. Port 80 TCP/IP HTTP (Web Interface) Fixed. Port 9450 TCP/IP Binary (Module Network) Configurable. Port 9460 UDP/IP Binary (Module Network) Configurable		
Communication (RS-485)	3 RS-485 communication interface ports, 1 for module communication and 2 for reader communication	2 RS-485 communication interface ports, 1 for module communication and 1 for reader communication	2 RS-485 communication interface ports, 1 for module communication and 1 for reader communication
Communication (Modem)	2400bps modem communication	-	-
Readers	2 reader ports** that can be configured for either Wiegand or RS-485 reader operation allowing the connection of up to 4 Wiegand readers or 4 RS-485 capable readers providing entry/exit control for two doors	1 RS-485 enabled reader port allowing the connection of 2 RS-485 capable readers providing entry/exit control for a single door	1 RS-485 enabled reader port allowing the connection of 2 RS-485 capable readers providing entry/exit control for a single door
Inputs	8 high security monitored inputs	2 high security monitored inputs	2 high security monitored inputs
Outputs	4 50mA (max) open collector outputs for reader LED and beeper or general functions	-	-
Relay Outputs	2 FORM C relays - 7A 250V max resistive/inductive	1 FORM C relay - 7A 250V max resistive/inductive	1 FORM C relay - 7A 250V max resistive/inductive
Operating Temperature	0°-49°C (32° - 122°F)		
Storage Temperature	-10° - 85°C (14° - 185°F)		
Humidity	0%-93% non condensing, indoor use only (relative humidity)		
Dimensions (L x W x H)	156 x 90 x 60mm (6.14 x 3.54 x 2.36")	78 x 90 x 60mm (3.07 x 3.54 x 2.36")	78 x 90 x 60mm (3.07 x 3.54 x 2.36")
Weight	376g (13.26oz)	167g (5.89oz)	205g (7.23oz)

Starter kits, additional hardware and optional accessories.



ICT's starter kits are designed as a cost-effective option to provide the components required to get your system underway quickly.



WX ACCESS STARTER KIT

- 1x ICT ProtegeWX DIN Rail Controller

- 2x TSEC Standard DESFire Card Readers

- 1x Protege DIN Rail 4A Intelligent Power Supply

WX INTRUSION STARTER KIT

- 1x ICT ProtegeWX DIN Rail Controller

- 1x Protege Touch Sense LCD Keypad

- 1x Protege DIN Rail 2A Intelligent Power Supply

PROTEGE TOUCH SENSE LCD KEYPAD

Modern and sleek, the Protege Touch Sense LCD Keypad enables you to monitor and control various items within the Protege system. Available in black or white to suit your decor.

PROTEGE MOBILE APP

Available exclusively from the iTunes App or Google Play stores, the Protege Mobile App enables you to monitor and control your home or business from anywhere. With the swipe of a finger you can connect to any of your sites, check the status, arm or disarm, control lights, locks, signage, heating – even cameras.



PROTEGE DIN RAIL 2 READER EXPANDER

Extends the system by providing:

- 2 doors (4 readers)
- 8 multi purpose inputs
- 2 Form C relay outputs
- 6 low current outputs



PROTEGE DIN RAIL 16 INPUT EXPANDER

Extends the system by providing 16 multipurpose inputs, ideal for adding PIR's and wireless receivers for medical and emergency devices.

Single Input and 8 Input Expander modules are also available.



PROTEGE DIN RAIL 8 OUTPUT EXPANDER

Extends the system by providing 8 Form C relay outputs, ideal for direct integrated control and lighting.



PROTEGE DIN RAIL 8 INPUT/4 OUTPUT EXPANDER

Extends the system by providing 8 multipurpose inputs and 4 Form C relay outputs, ideal for large distributed intruder detection and building control systems.



PROTEGE DIN RAIL INTELLIGENT POWER SUPPLY

Provides 12VDC power, ideal for running security, access control or automation devices, along with large numbers of Protege network powered modules in the same installation. Available in 2A, 4A and 8A models.



PROTEGE DIN RAIL MODULE NETWORK REPEATER

Connects to the system via Ethernet and provides 3 optically isolated RS-485 ports, allowing the module network to be extended to remote locations or to be separated into spurs.



Protege DIN Rail. Built Tough.

To give your integrated electronic security systems the competitive edge, you could stick to what you know: fragile circuit componentry that hasn't changed for years. Or you could choose an altogether more powerful solution. Our DIN Rail compatible units are compact, robust and elegant. In this day and age, why would you work with anything else?

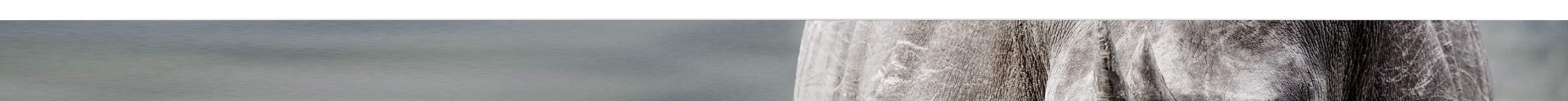

DESIGNED WITH AN INDUSTRY STANDARD DIN RAIL MOUNT ENCLOSURE, THE DIN RAIL RANGE NOT ONLY LOOKS GREAT, IT INTEGRATES SEAMLESSLY INTO LARGE SCALE INSTALLATIONS ALONGSIDE HIGH END HVAC AND ELECTRICAL SWITCHBOARD COMPONENTS.



Enclosed design provides more durability and protects internal circuitry from physical damage or electrostatic discharge.



Front panel LED indicators show the status of devices at a glance, making servicing and diagnosis quick and simple.

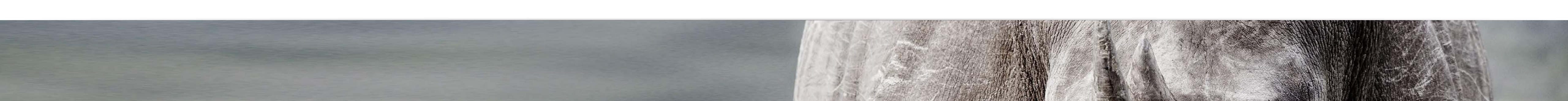

Compact size translates to a higher installation density, taking up less valuable real estate and providing you more control in less space.



Removable plug-in terminals allow for easy servicing and rapid deployment.



Listed to UL/ULC standards, and compliant with the FCC, CE, and C-Tick international safety and emission standards.

tSec. Ultimate range.
Ultimate choice.



Sleek and stylish, and with a range of optional features, the tSec series has a solution for everyone. Available in three sizes, multiple card capabilities, with an optional keypad, and in a choice of black or white, you can select the model to fit your needs and your decor. Because one size does not fit all.



MULTI CARD TECHNOLOGY

Available with either 125kHz proximity or 13.56MHz smart card capability, or as a multi technology reader that combines both capabilities in a single unit delivering maximum compatibility while providing a path forward to the latest technology.

The Multi Technology Reader is ideal for organizations that wish to transition to smart technology at their own pace, as it means they don't need to replace all their cards upfront.

FLEXIBLE COMMUNICATION

Choose between the intelligent RS-485 connection for fast, flexible, secure communication, or Wiegand for compatibility with all standard access control systems. RS-485 provides the added benefits of being easier and more cost effective to wire and deploy, and allows for direct integration with Protege systems enabling you to make changes on the fly once readers are installed. RS-485 also allows for longer cable runs and offers a simpler firmware update process.

IP65 PROTECTION

The IP65 environmental rating provides a high degree of protection from the elements, making the TSEC Reader suitable for harsh environments. Readers can be mounted indoors or outdoors, located anywhere from the car park gate to the office door.

CLONE DETECTION

Built-in clone detection (if using ICT Secured Mifare) prevents access when a copied credential is presented, with a further option to modify the card so that it can no longer be read.

Integrated Control Technology.



There's a reason elephants are vegetarian. After a clumsy run-up, the eight-tonner might gather some serious speed, but it's never going to make the most effective hunter. Now think of a panther. Compact, sleek, light on its feet. You get the idea.

$$\text{Agility} = \frac{\text{Speed}}{\text{Size}}$$



ALTOGETHER MORE AGILE THAN YOUR AVERAGE BEAST

At ICT, we're committed to keeping our organization streamlined because it allows us to attack your security requirements elegantly and efficiently. Our processes are smart, our people responsive, our systems tailored. The result is a company that's altogether more agile than your average beast.

ELECTRONIC ACCESS CONTROL, IN YOUR CORNER

Our team is diverse enough to handle any query, but close-knit enough to ensure the right hand always communicates with the left. We apply the same targeted approach to our technology design, to provide solutions that make for cost-effective and efficient implementation and operation.



INNOVATION IS IN OUR DNA

With more than 35% of our staff dedicated to research and development, innovation is a core part of the ICT DNA. When you invest in an ICT solution, you gain first hand access to cutting edge technology and can rest assured that your investment is protected by the best in the industry.



100% QUALITY, FULLY TESTED

All ICT products are fully tested (no batch testing) to ensure they meet rigorous safety criteria with a highly robust quality management system that ensures superior quality.

Want to find out more?

Talk to us today to discover how a ProtegeWX solution can benefit your organization.