



Digital Security System

2/5 Megapixel 12x/23x H.265 PoE Mini PTZ Dome Network Camera



KEY FEATURES

- ▶ Smart Stream (Bandwidth, storage and bit rate save with Smart Stream ON, eg, H.265+ save 70%~80% bandwidth of H.264.)
- ▶ 0.002Lux Starlight (Deliver high detailed color images even in low light environment reaching 0.002Lux.)
- ▶ 140dB Super WDR (Excellent performance even when the ratio of the luminosity of brightest and darkest is up to 140dB)
- ▶ Advanced Functions (Boasting to support various advanced functions such as HLC, Defog, ROI.)
- ▶ Smart PTZ Motion Detection (Pan and tilt to the position of motion detected area automatically and zoom in synchronously)
- ▶ 255 Preset Positions (The user can easily control the lens position via mouse to monitor interested area and set up to 255 preset positions for patrolling.)
- ▶ Video Content Analysis (With 10 detection modes, VCA greatly enhances the performance bringing comprehensive surveillance functions.)
- ▶ Keyboard Control (Shortcut keys for PTZ control via keyboard.)

12x/23x CdhjW Ncca

The 12x/23x optical room can room up to distant subjects while still maintaining the clarity, delivering high quality video over the entire zoom range.

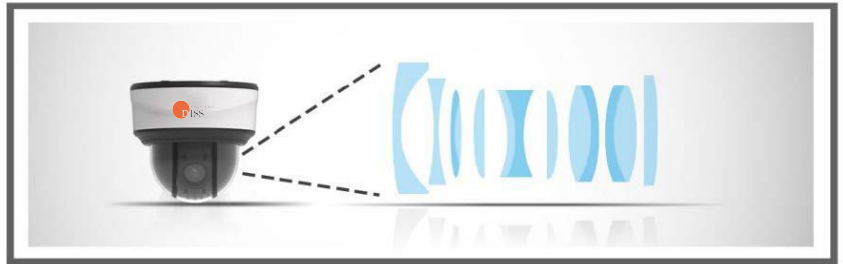

Smart IR II Technology

It allows the camera to catch better images regardless of object distance with High Beams and Low Beams whose brightness could be adjusted Anti-reflection Panel protects the lens from IR interference.

High Speed & Precise Movement

With a sophisticated pan/tilt mechanism, the 12x/23x H.265 Mini PoE PTZ Dome Network Camera provides fast, precise movement with 360° endless pan and -5 ~ 90° (Auto Flip). Maximum pan speed of 240°/s and tilt speed of 200°/s make the camera a mighty Speed Dome model.

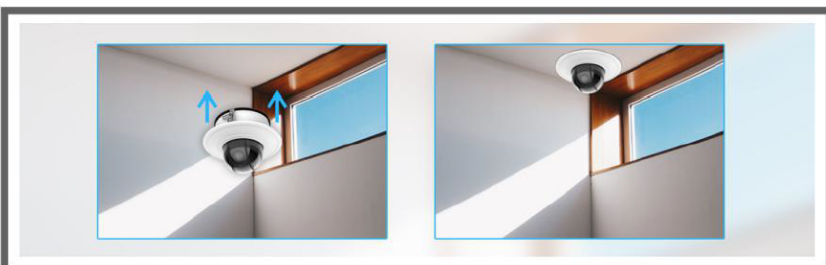

Recessed Installation

With recessed installation, the 12x/23x H.265 Mini PoE PTZ Dome Network Camera is easily blend in with the environment to provide discreet surveillance.

12x/23x H.265 Mini PTZ Dome Network Camera



	Model	DI-MS212 (2MP/12x)	DI-MS223 (2MP/23x)	DI-MS512 (5MP/12x)	DI-MS523 (5MP/23x)
Camera	Image Sensor	1/2.8" Progressive Scan CMOS			
	Min. Illumination	Color: 0.002Lux@F1.2 B/W: 0Lux with IR on		Color: 0.005Lux@F1.2 B/W: 0Lux with IR on	
	WDR	140dB Super WDR		120dB Super WDR	
	Shutter Time	1/100000s~1s			
	Day&Night	ICR Filter Auto Switch			
	S/N	>55dB			
	Digital Zoom	16x			
Lens	Focal Length	5.3~64mm @F1.6~F2.8, 12x Optical Zoom	5~117mm @F1.5~F3.5, 23x Optical Zoom	5.3~64mm @F1.6~F2.8, 12x Optical Zoom	5~117mm @F1.5~F3.5, 23x Optical Zoom
	Zoom Speed	Approx 3.1s (Optical Wide-Tele)			
	Field of View	H61°~H5°/D69°~D5°/ V36°~V2°	H60°~H3°/D69°~D4°/ V35°~V2°	H57°~H4°/D69°~D5°/ V44°~V1°	H55°~H3°/D68°~D4°/ V42°~V2°
	Minimum Working Distance	1000~1500mm (Wide-Tele)(5.3~64mm) / 100~1500mm (Wide-Tele)(5~117mm)			
PTZ	Pan Range / Pan Speed	360° endless; Pan Manual Speed: 0.5°~180°/s, Pan Preset Speed: 240°/s			
	Tilt Range / Tilt Speed	-5°~90° (Auto Flip); Tilt Manual Speed: 0.5°~120°/s, Tilt Preset Speed: 200°/s			
	Proportional Zoom	Support			
	Preset Quantity	255			
	Preset Freezing	Support			
	Patrol	8 Patrols, up to 48 presets each patrol			
	Pattern	4 Patterns			
	Power Off Memory	Support			
	PTZ Position Display	ON/OFF			
IR	3D positioning	Support			
	IR Distance IR Angle	Up to 120m Auto/Manual			
Video	Max. Image Resolution	1920x1080		2592x1944	
	Primary Stream	60fps@(1920x1080, 1280x960, 1280x720, 704x576)		30fps@(2592x1944), 60fps@(1920x1080, 1280x960, 1280x720, 704x576)	
	Secondary Stream	30fps@(704x576, 640x480, 640x360, 352x288, 320x240, 320x192, 320x176)			
	Tertiary Stream	30fps@(1920x1080, 1280x720, 704x576, 640x480, 640x360, 320x240, 320x192, 320x176)			
	Video Compression	H.265+/H.265(HEVC)/H.264+/H.264/MJPEG			
	Video Bit Rate	16Kbps~16Mbps(CBR/VBR Adjustable)			
	Image Setting	Brightness/Contrast/Saturation/Sharpness			
Network	Ethernet	1*RJ45 10M/100M Ethernet Port			
	Network Storage	NAS(Support NFS, SMB/CIFS)			
	Protocol	IPv4/IPv6, TCP, UDP, RTP, RTSP, RTCP, HTTP, HTTPS, DNS, DDNS, DHCP, FTP, NTP, SMTP, SNMP, UPnP, SIP, PPPoE, VLAN, 802.1x, QoS, IGMP, ICMP, SSL			
Audio	Audio Compression	G.711/AAC			
	Audio I/O	1/1			
System	Alarm I/O	1/1			
	RS485	Support			
	Storage	Support microSD/SDHC/SDXC Card Local Storage, up to 256G			
	Advanced Function	Auto Tracking, Privacy Masking, BLC, HLC, 2D DNR, 3D DNR, ROI, Defog, AWB, EIS, IP Address Filtering, AGC, Anti-flicker, Corridor Mode, Deblur			
	SIP/VoIP Support	Yes, Voice & Video-over-IP			
	Event Trigger	Motion Detection, Network Disconnection, External Input, Audio Alarm, etc.			
	Event Action	FTP Upload, SMTP Upload, SD Card Record, External Output, SIP Phone, PTZ Motion, HTTP Notification, etc.			
	Video Analysis (Optional)	Region Entrance, Region Exiting, Advanced Motion Detection, Tamper Detection, Line Crossing, Loitering, Human Detection, People Counting, Object Left, Object Removed			
System Compatibility	ONVIF Profile S & G & T				
General	Working Condition	Temperature: -40℃~60℃ / Humidity: 0~90%(Non-condensing)			
	Power Supply	PoE (802.3at) / DC 12V/2A ±10%			
	Power Consumption	9W MAX/12W MAX (With IR on)		11W MAX/14W MAX (With IR on)	
	Weather Proof/Housing	Up to IP66-rated for Weather-resistant Performance / Vandal-proof IK10-rated Metal Housing			
	Surge Protection	4KV			
	Dimensions/Weight	Φ183mmX174.8mm/2Kg			

12x/23x H.265 Mini PTZ Dome Network Camera



Structure Diagrams

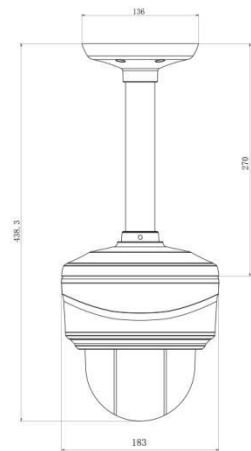
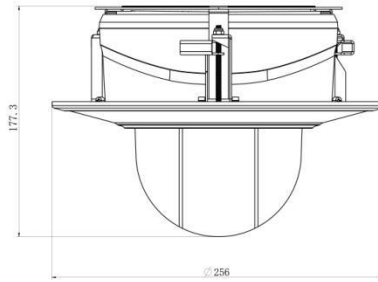
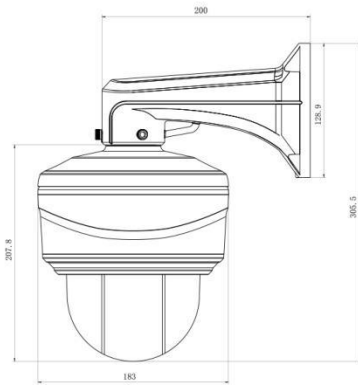
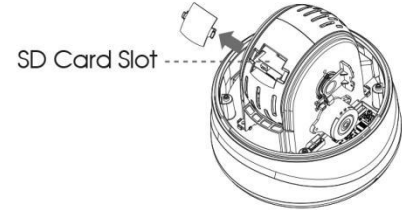
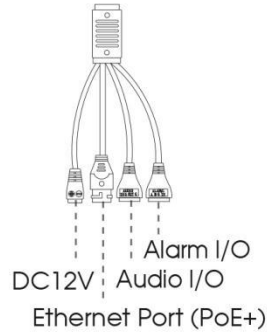
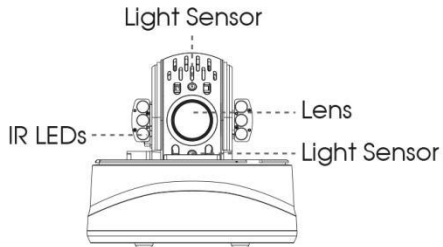

Units: mm

Accessories Support

A43 Junction Box

Weight: 1000g
Dimensions: 195*164*80mm



A77 Wall Mount

Weight: 650g
Dimensions: 262*185*138mm



A78 Recessed Mount

Weight: 715g
Dimensions: 256*256*94mm



A79 Pendant Mount

Weight: 850g
Dimensions: 256*256*245mm

